



CorePro LED PLC 4P



CorePro LED PLC 9W 840 4P G24q-3

The CorePro LED PLC 4P integrates a LED light source into a traditional fluorescent form factor. This product is the ideal solution for uplamping in general lighting applications: it meets basic lighting requirements, offers significant energy savings, and is environmentally friendly.

Product data

General Information	
Cap-Base	G24q-3
Nominal lifetime	30,000 hour(s)
Switching Cycle	50,000
Lighting Technology	LED
Flux measurement reference	Sphere
Light Technical	
Color Code	840 [CCT of 4000K]
Beam Angle (Nom)	120 degree(s)
Luminous Flux	1,000 lm
Luminous Efficacy (rated) (Nom)	100.00 lm/W
Color Designation	Cool White (CW)
Correlated Color Temperature (Nom)	4000 K
Color Consistency	<6
Color rendering index (CRI)	83
LLMF At End Of Nominal Lifetime (Nom)	70 %
Photobiological safety according to EN 62471	RG0
Operating and Electrical	
Line Frequency	30000-80000 Hz
Input Frequency	30000-80000 Hz
Power Consumption	9 W

Lamp Current (Max)	400 mA
Lamp Current (Min)	250 mA
Starting Time (Nom)	0.5 s
Warm-up time to 60% light	0.5 s
Power Factor (Fraction)	0.9
Voltage (Nom)	20-50 V
LED alternative to fluorescent lamp power	26 W
Inrush current at mains	-
Max. lamp no. on MCB B type 10A - Mains	-
Max. lamp no. on MCB B type 10A – EM ballast without Compensation Capacitor.	-
Max. lamp no. on MCB B type 10A – EM ballast with Compensation Capacitor.	-
Max. lamp no. on MCB B type 16A - Mains	-
Max. lamp no. on MCB B type 16A – EM ballast without Compensation Capacitor.	-
Max. lamp no. on MCB B type 16A – EM ballast with Compensation Capacitor.	-
Ballast Compatibility	HF

Temperature	
Ambient temperature range	-20 °C to 35 °C

CorePro LED PLC 4P

T-Case Maximum (Nom)	76 °C
Controls and Dimming	
Dimmable	No
Mechanical and Housing	
Product Length	200 mm
Bulb Shape	PL-C
Approval and Application	
Energy Efficiency Class	F
Energy Saving Product	Yes
Approval Marks	RoHS compliance
Energy Consumption kWh/1000 h	9 kWh
EPREL Registration Number	403551
CE mark	Yes
EU RoHS compliant	Yes

Product Data

Order product name	CorePro LED PLC 9W 840 4P G24q-3
Full product name	CorePro LED PLC 9W 840 4P G24q-3
Full product code	871869654117300
Order code	929001200902
Material Nr. (12NC)	929001200902
Numerator - Quantity Per Pack	1
Net Weight (Piece)	0.088 kg
EAN/UPC - Product/Case	8718696541173
Numerator - Packs per outer box	10
EAN/UPC - Case	8718696541180

Dimensional drawing

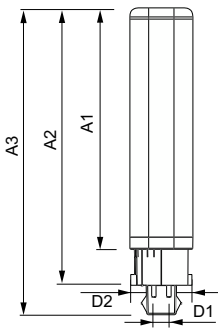

Product	D1	D2	A1	A2	A3
CorePro LED PLC 9W 840 4P G24q-3	24.3 mm	28.4 mm	128.8 mm	148 mm	163.6 mm

Photometric data

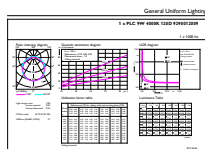

General uniform lighting - CorePro LED PLC 9W 840 4P G24q-3

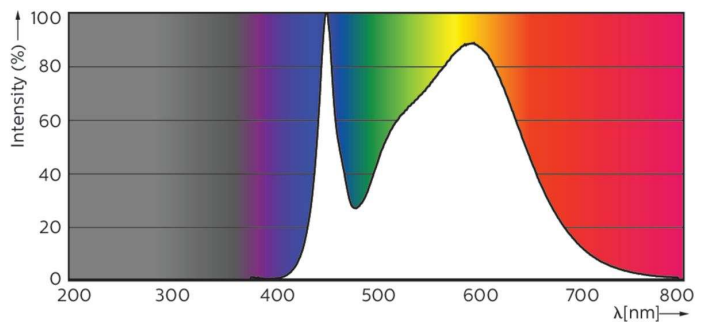

Spectral Power Distribution Colour - CorePro LED PLC 9W 840 4P G24q-3

CorePro LED PLC 4P

Photometric data

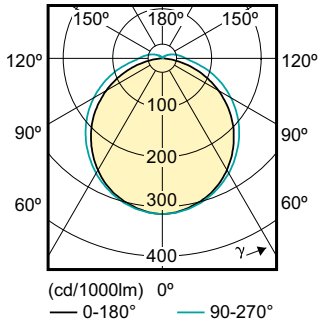

Light Distribution Diagram - CorePro LED PLC 9W 840 4P G24q-3

Lifetime

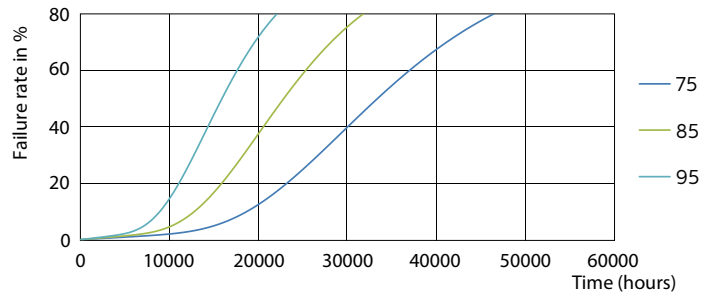
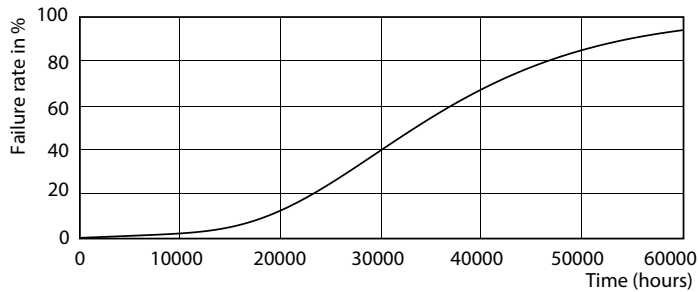

LEDtube PLC 100mm 9W G24Q-3 830 950lm

LEDtube PLC 100mm 9W G24Q-3 830 950lm

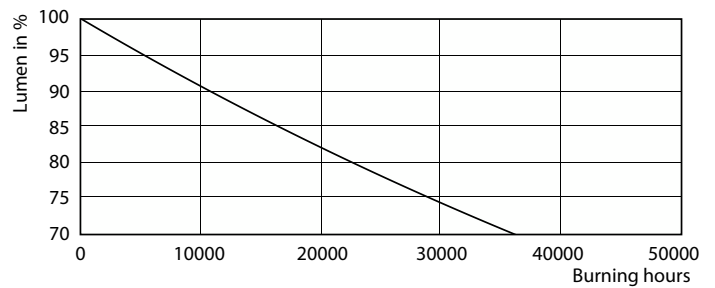
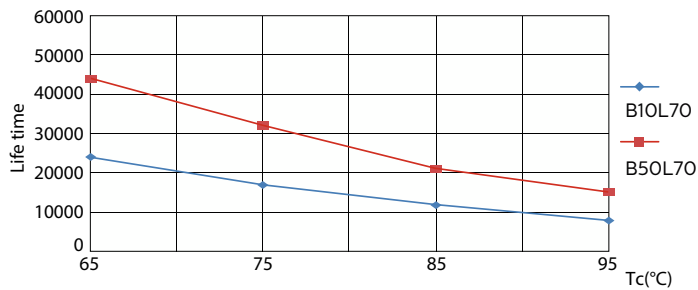

LEDtube PLC 100mm 9W G24Q-3 830 950lm

Lumen Maintenance Diagram - CorePro LED PLC 9W 840 4P G24q-3

CorePro LED PLC 4P

Lifetime

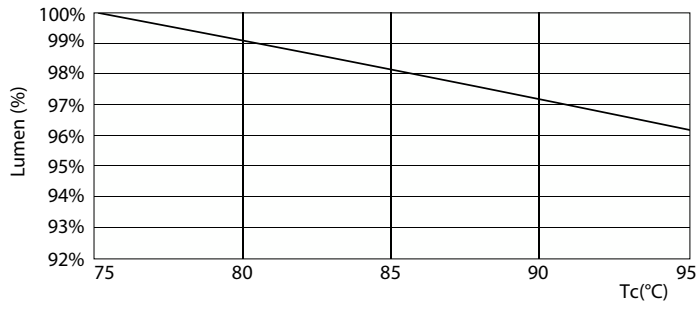

Lumen Maintenance Diagram - CorePro LED PLC 9W 840 4P G24q-3

