

R-BOX 240-8



ABS

IP44



1

PN-EN 61439-1, PN-EN 61439-3

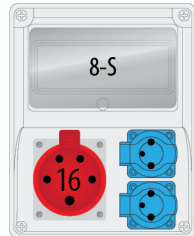

B.1801

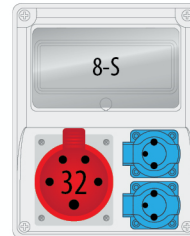

B.1802

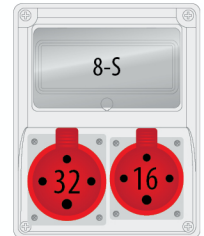

B.1803

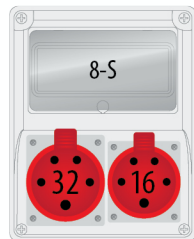

B.1804

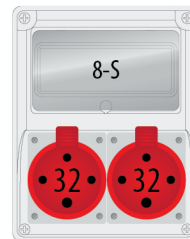

B.1805

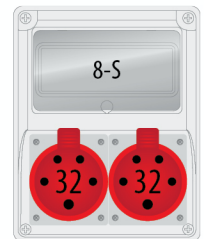

B.1806

On the customer request, distribution boxes are available in all possible configurations.

Distribution box R-BOX Series
- appropriate PG cable gland inside

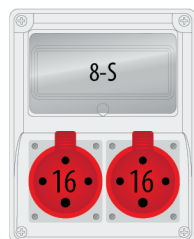

B.1807

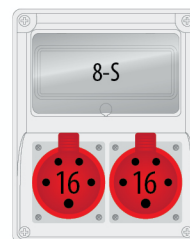

B.1808

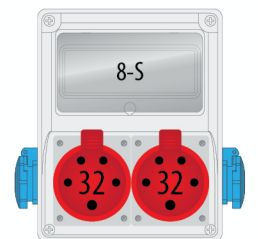

B.1809

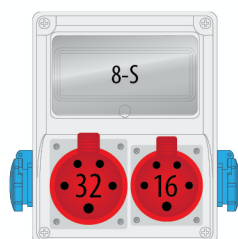
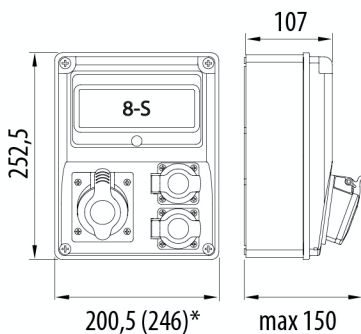

B.1810

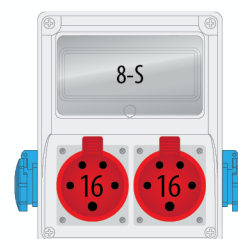

B.1811

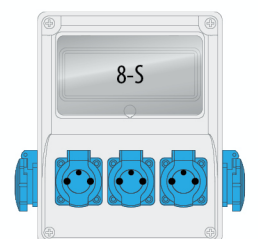

B.1812

* Refers to the dimension of the distribution box with two VZ sockets